



5499 W. BROOKS STREET MONTCLAIR, CA 91763
 TEL: 909-635-1335 FAX: 909-635-1339
WWW.PACIFICDUCT.COM

ROUND DUCT AND FITTINGS

SUBMITTAL SHEET

Unreinforced, Positive Pressure, Single-wall, Round Duct Gauges for Galvanized, Polyvinyl-Chloride (PVC)-Coated Steel, Nongalvanized Carbon Steel, or Stainless Steel

Spiral Duct Construction		
Maximum +2 W.G. / Static Pressure		
Duct Dia. Inches	Spiral Seam Gauge	Longitudinal Seam Gauge
3 - 8	26	26
9 - 14	26	26
15 - 22	26	24
23 - 26	24	24
27 - 30	24	22
31 - 36	22	22
37 - 50	20	20
51 - 60	20	18
61 - 84	18	16

Spiral Duct Construction		
Maximum +4 W.G. / Static Pressure		
Duct Dia. Inches	Spiral Seam Gauge	Longitudinal Seam Gauge
3 - 12	26	26
13 - 16	26	24
18	24	24
19 - 26	24	22
27 - 36	22	20
37 - 50	20	20
51 - 60	18	18
61 - 84	18	16

Spiral Duct Construction		
Maximum +10 W.G. / Static Pressure		
Duct Dia. Inches	Spiral Seam Gauge	Longitudinal Seam Gauge
3 - 10	26	26
11 - 14	26	24
15 - 26	24	22
27 - 36	22	20
37 - 50	20	20
51 - 60	18	18
61 - 84	18	16

Applies to low pressure systems 2" positive static water. Round gauge selection for Galvanized Steel as displayed in SMACNA HVAC Duct Construction Standard Manual

Job Name: _____

Location: _____

Mechanical Contractor: _____

Job No: _____

Manufacturer: _____

Date: _____

SUBMITTAL SHEET

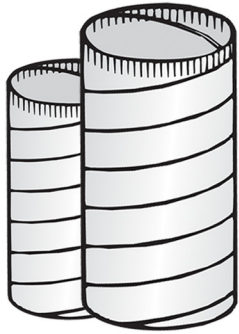

Spiral Pipe

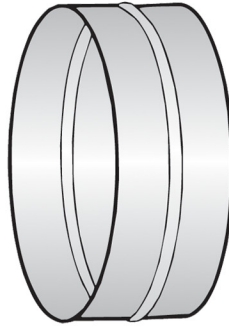

Spiral Coupling

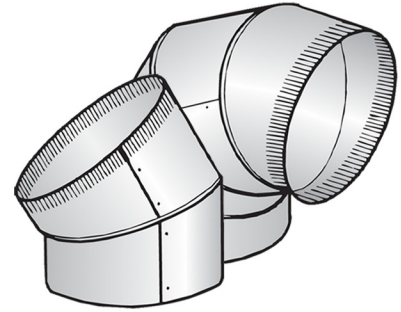

45/90 Elbows

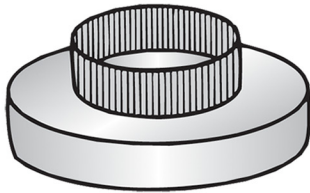

**Reducer
(Cookie Cutter)**

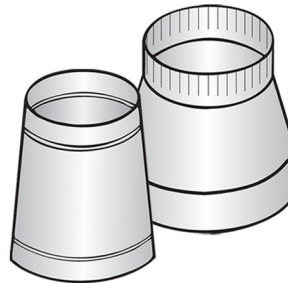

**Taper/
Taper W/Collars**

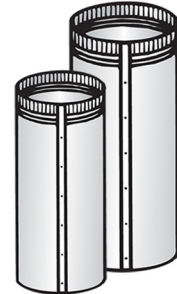

**KD Pipe/
Snap Lock**

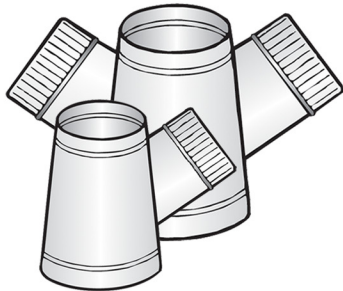

**T-wye/
Dual T-wye**

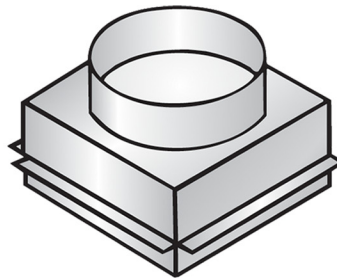

Ceiling Box

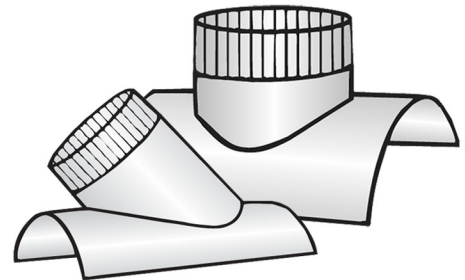

**45/90 Radius
Saddle**

Job Name: _____

Location: _____

Mechanical Contractor: _____

Job No: _____

Manufacturer: _____

Date: _____