



5499 Brooks Street • Montclair, CA 91763
Tel (909) 635-1335 • Fax (909) 635-1339

Round Duct & Fittings

SUBMITTAL SHEET

ROUND DUCT GAUGE SELECTION UNREINFORCED POSITIVE PRESSURE GALVANIZED STEEL

CMC STANDARDS		
DIAMETER PIPE (SIZE)	SPIRAL SEAM GAUGE	FITTINGS/ DUCTWORK GAUGE
4"-14"	26	26
15"-23"	24	24
24"-36"	22	22
37"-50"	20	20
51"-60"	18	18
Over 60"	14	14

Applies to low pressure systems 2" positive static water. Round gauge selection for galvanized Steel as displayed in CMC HVAC *Duct Construction Standard Manual*

Job Name: _____

Location: _____

Mechanical Contractor: _____

Job No: _____

Manufacturer: _____

Date: _____

Round Duct & Fittings

SUBMITTAL SHEET

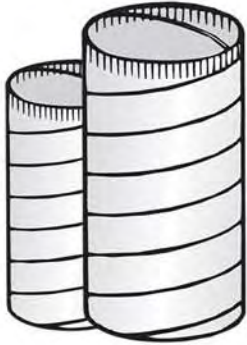

Spiral Pipe



Spiral Coupling

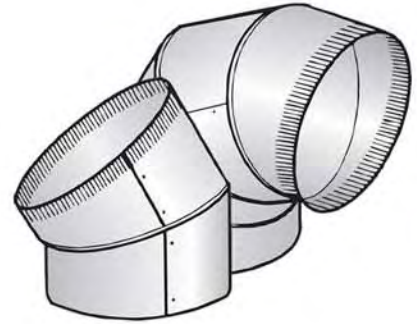

45/90 Elbows



Reducer
(Cookie Cutter)

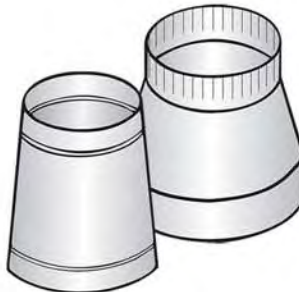

Taper/
Taper W/Collars

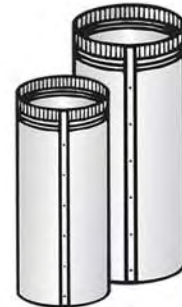

KD Pipe/
Snap Lock

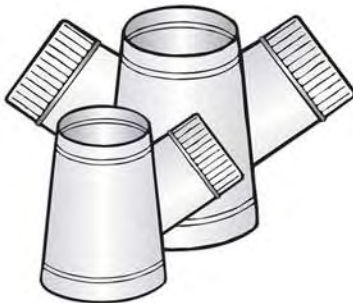

T-wye/
Dual T-wye

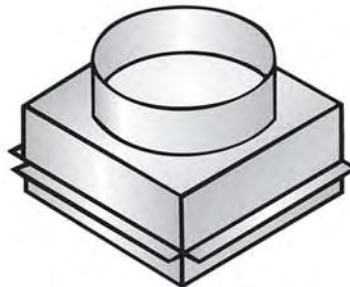

Ceiling Box

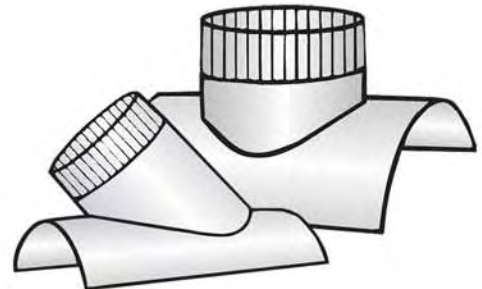

45/90 Radius
Saddle

Job Name: _____

Location: _____

Mechanical Contractor: _____

Job No: _____

Manufacturer: _____

Date: _____